

2MP HD Fixed IR Turret Analog Camera

NEU-AD112-28-CA



Introduction

NEU-AD112-28-CA is a 2MP HD Fixed IR Turret Analog Camera with a high-performance 1/3-inch CMOS sensor. It supports TVI/AHD/CVI/CVBS, which effectively enhances product adaptability and diversity of networking solutions. With SYV-75-3 or other coaxial cable types the camera can achieve low-cost, long-distance, anti-interference, and low delay mega-pixel HD video transmission. The camera supports IR cut filter and provides color images at daytime and black/white images at night.

Features

- 2MP high quality image
- TVI/AHD/CVI/CVBS
- IR-cut filter with auto switch (ICR)
- Supports 180° horizontal flip , 180° vertical flip
- OSD configuration menu, easy to operate
- IP67 waterproof and dustproof design, high reliability
- OSD configuration menu in 11 languages
- 3-Axis

Specifications

Model	NEU-AD112-28-CA
Sensor	
Pixel	2MP
Size	1/3"
Minimum illumination	0.02 lux (F2.0, AGC ON) 0 lux (IR on)
Lens	
Lens	2.8mm
Lens mount	M12
Angle of view	H: 90.5° V: 49.6° D: 109.5°
Illuminator	
Illuminator	One IR illuminator
Illumination distance	20m
Lifetime	≥60,000 hours
Image	
Resolution	1080P: 1920(H)×1080(V) 720P: 1280(H) ×720(V)
Frame rate	TVI/AHD/CVI: 1080P@30fps, 1080P@25fps; 720P@30fps, 720P@25fps CVBS: PAL, NTSC
Shutter time	PAL: 1/25s-1/50000s NTSC: 1/30s-1/50000s
Image	
Exposure mode	4 modes: Global (default), BLC, HLC, DWDR
Day/Night	3 modes: Auto (default), Day, Night
Digital noise reduction	2D
White balance	Two modes: Auto (default), Manual
WDR	DWDR
Smart IR	Support
Flip	Supports 180° horizontal flip , 180° vertical flip.
Interface	
Power	5.5mm power interface
Video output	BNC, supports TVI/AHD/CVI/CVBS
Operating environment	
Temperature	-30 to 60 (-22 to 140)
Humidity	≤95% (RH, non -condensing)
Surge protection	4KV
Ingress protection	IP67
General	
Power	DC 12V(±25%), with reverse polarity protection and surge protection, Max 2.88W
Mount	Surface mount (default), optional backbox, wall mount bracket
Dimensions	Φ118mm*96mm (diameter*height)
Material	Plastic
Weight	182g(0.401lb)

Certification

CB, CE, FCC

Dimensions

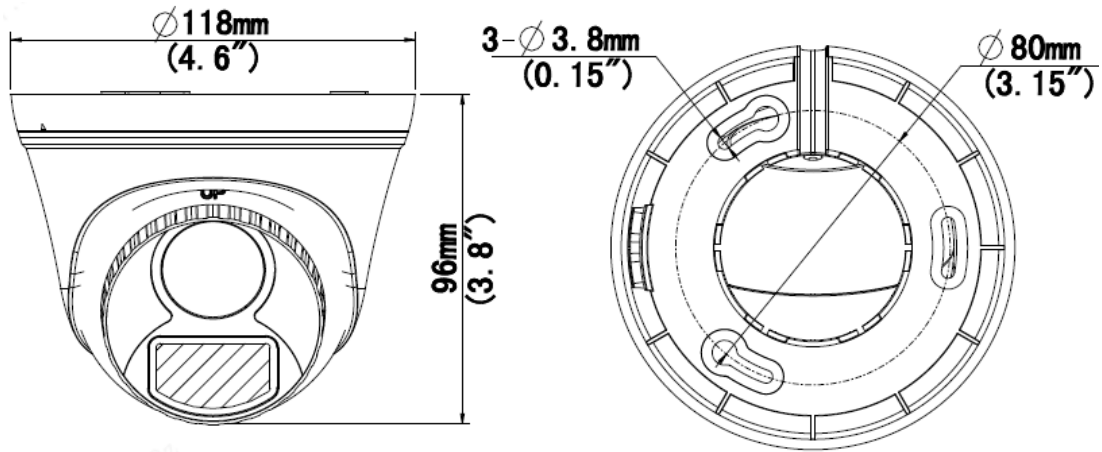

NEU-AD112-28-CA

Accessories

TR-JB03-I-IN

Junction Box



TR-UP06-IN

Pole Mount



PWR-DC1201A-UK

TR-JB07/WM03-G-IN

Wall Mount



TR-UC08-C

Corner mount

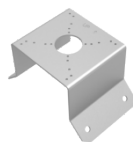

PWR-DC1201A-US

TR-WM03-D-IN

Wall Mount

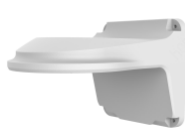

TR-SE24-A-IN

Pendant Mount



PWR-DC1201A-EU

TR-WM07P-B

Wall mount



TR-CM24-IN

Pendant Mount



TR-A01-IN

Waterproof Joint



TR-SE24-IN

Pendant Mount



Wall Plug-in UK
Power Adapter



Wall Plug-in US Power
Adapter



Wall Plug-in EU
Power Adapter



Mount

TR-JB07/WM03-G-IN(TR-WM03-D-IN)+TR-UP06-IN

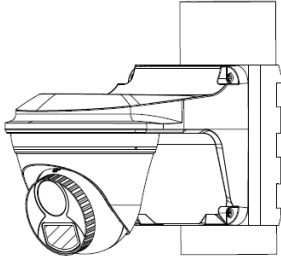

TR-JB03-I-IN

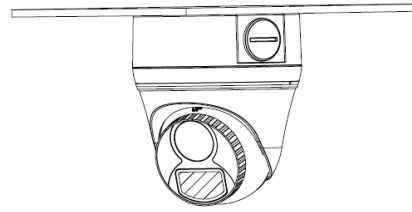

11-33-ED-1

TR-JB07/WM03-G-IN(TR-WM03-D-IN)+TR-UC08-C

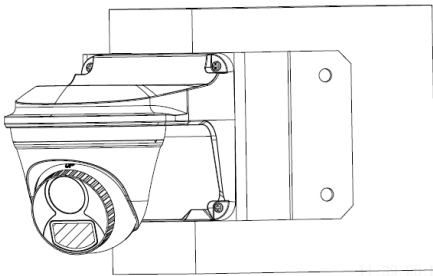

TR-CM24-IN+TR-JB03-I-IN

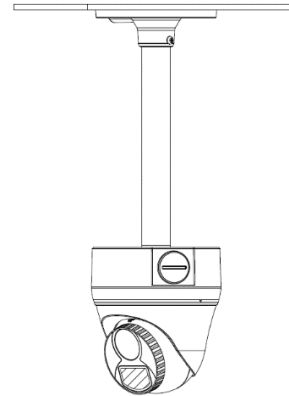

TR-WM07P-B

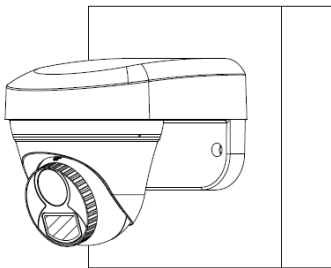

TR-JB07/WM03-G-IN(TR-WM03-D-IN)

